

















- JP1  GND
- JP2  VDD
- JP3  SCL
- JP4  SDA
- JP5  GP0/A0
- JP6  GP1/A1
- JP7  GP2/A2
- JP8  GP3/A3
- JP9  +V

- GND  JP10
- BAT-  JP11
- BAT-  JP12
- BAT+  JP13
- BAT+  JP14
- GND  JP15
- GND  JP16
- VIN  JP17

### STEP-DOWN

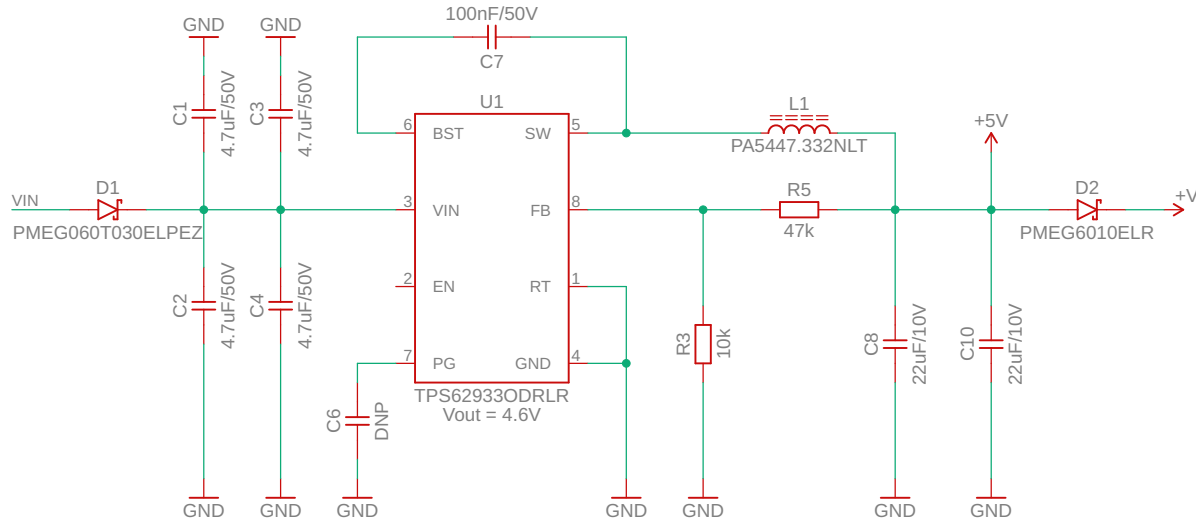

### Li-Ion CHARGER Iset = 450 mA

